

# Konzeptvorstellung

Team: Caroline Herschel

# Position

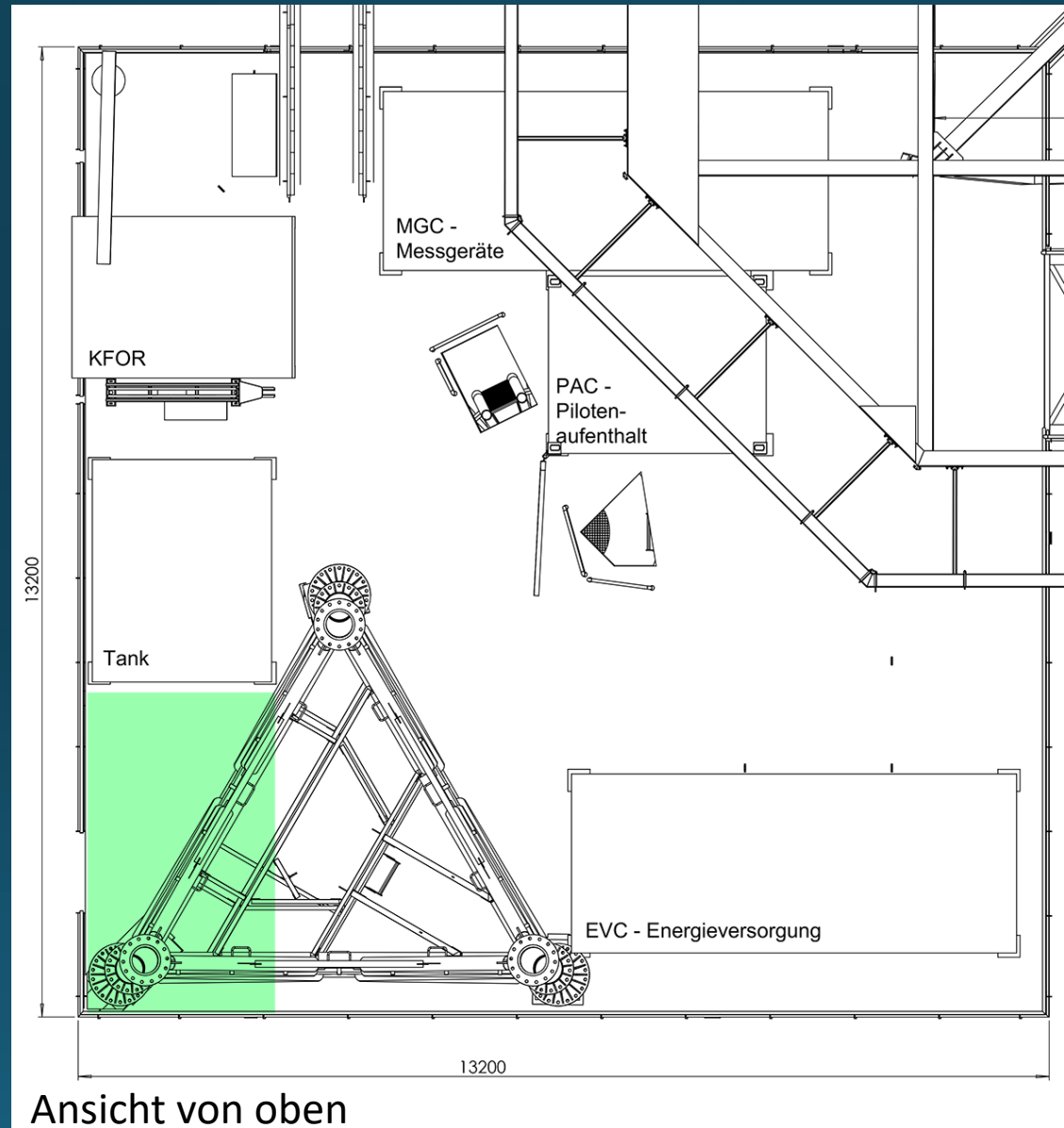

# Gesamtsystem

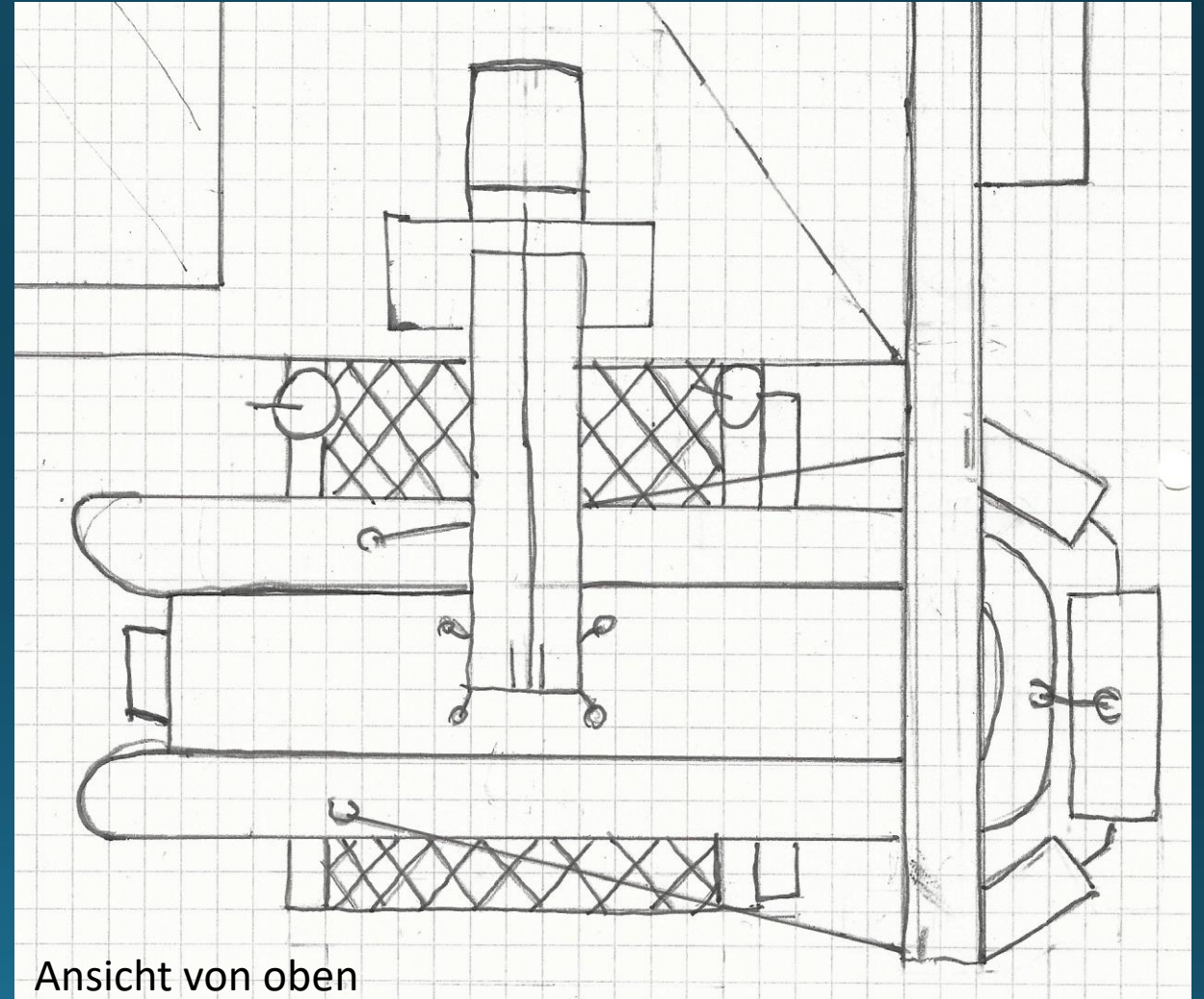
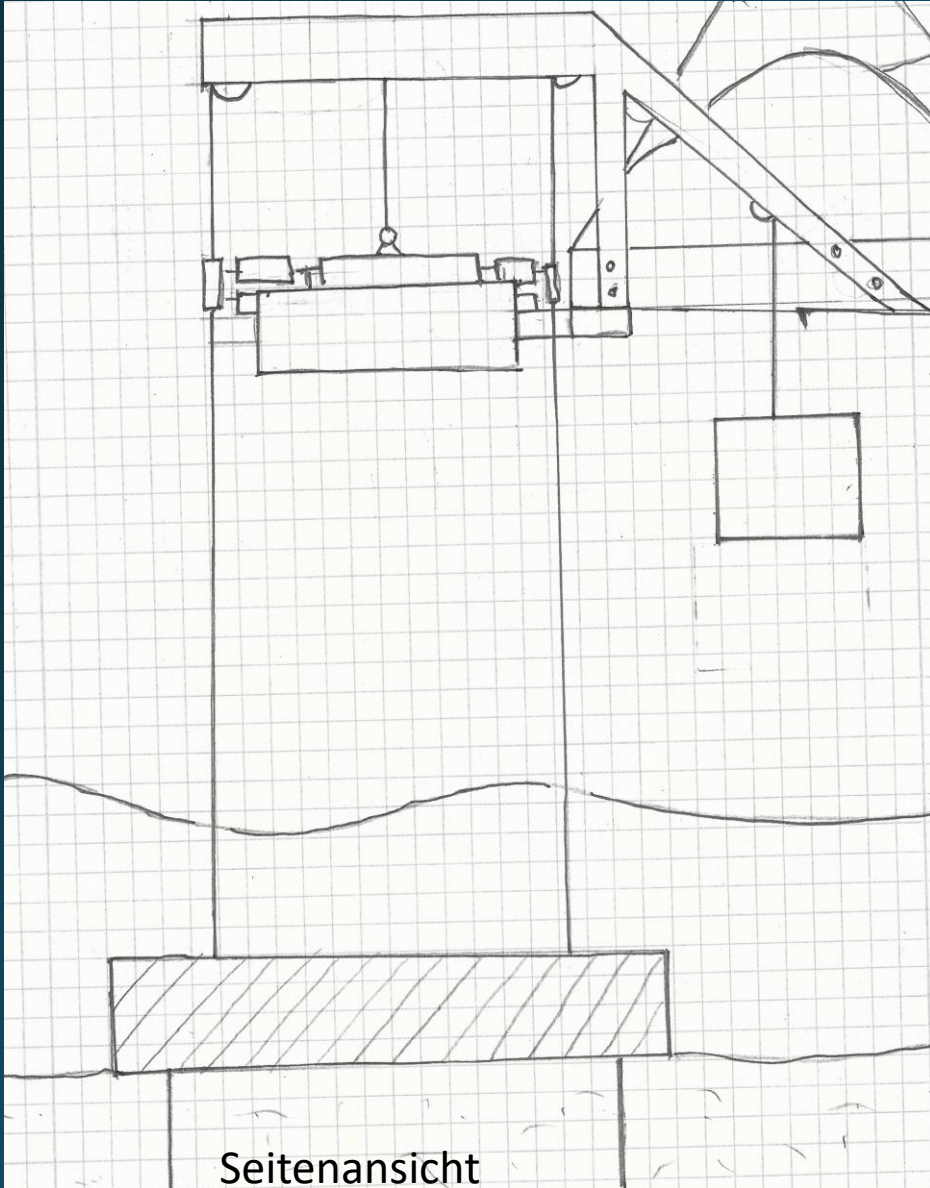

# Lagerung

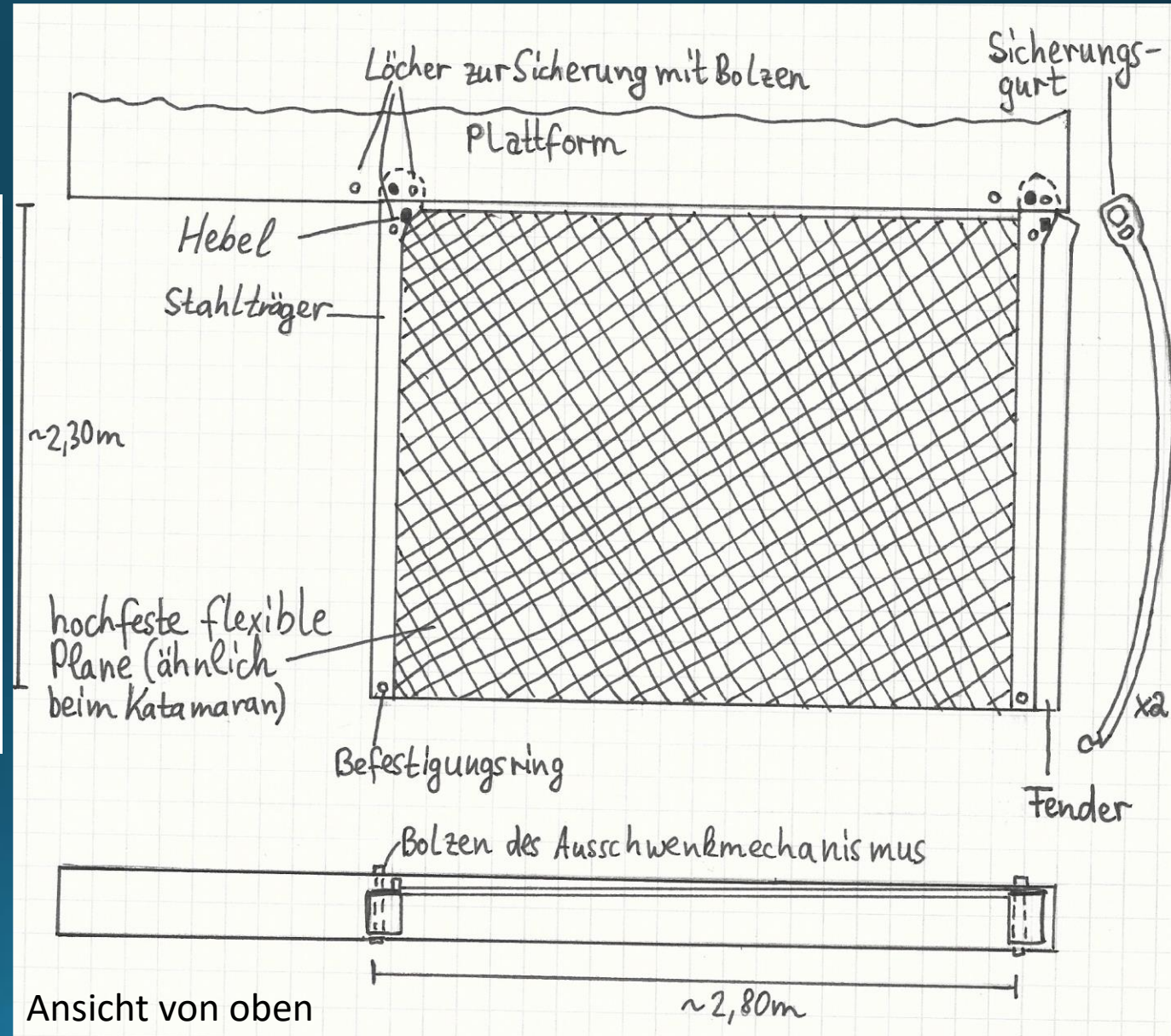
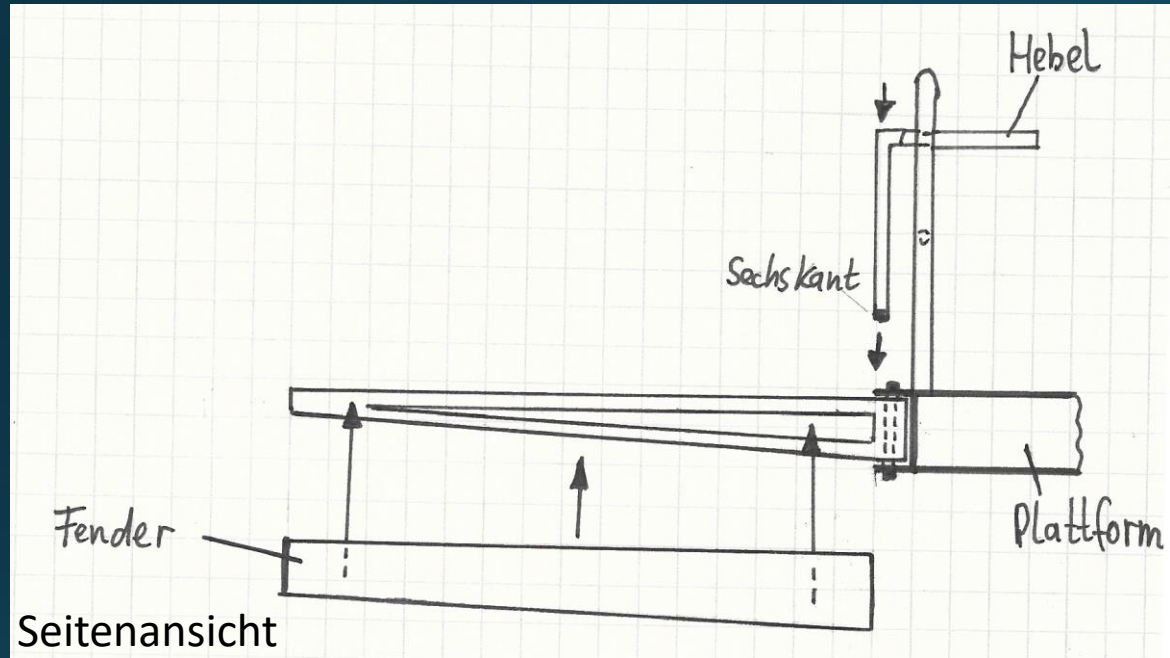

# Kran

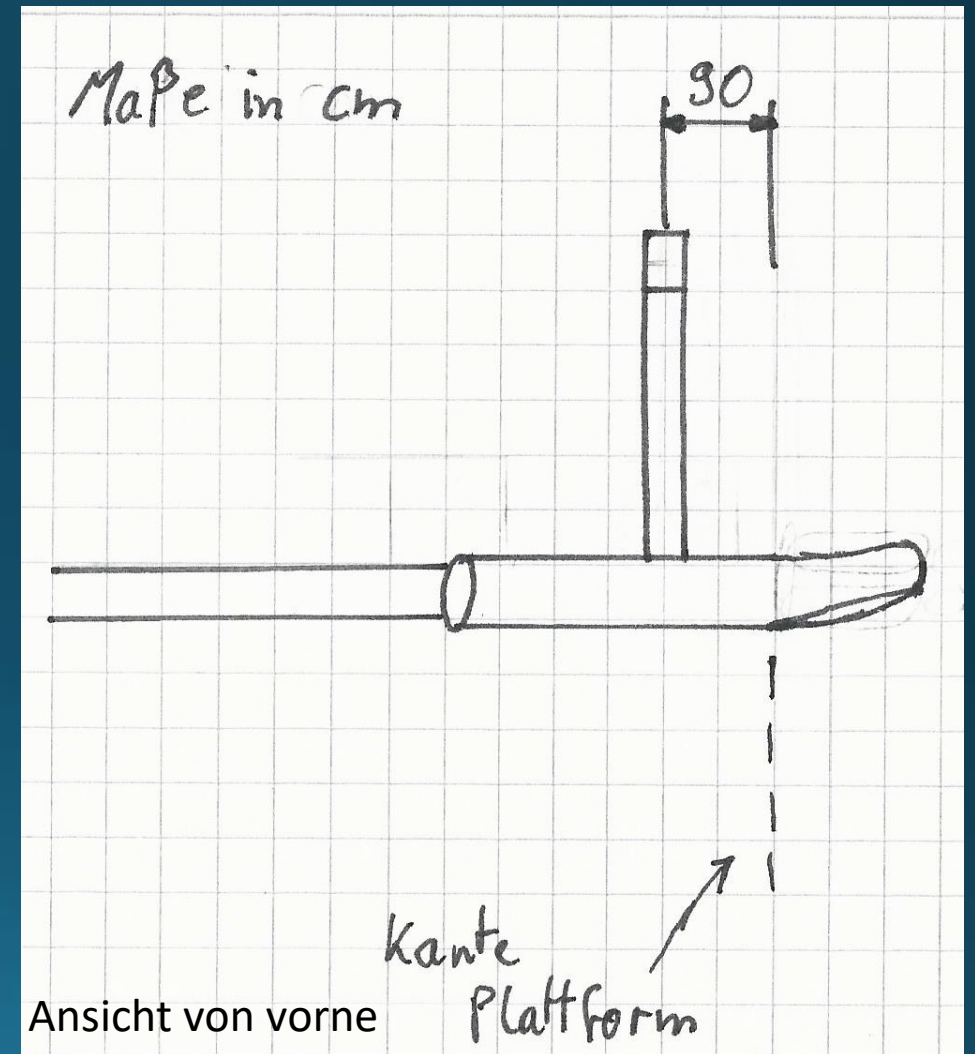
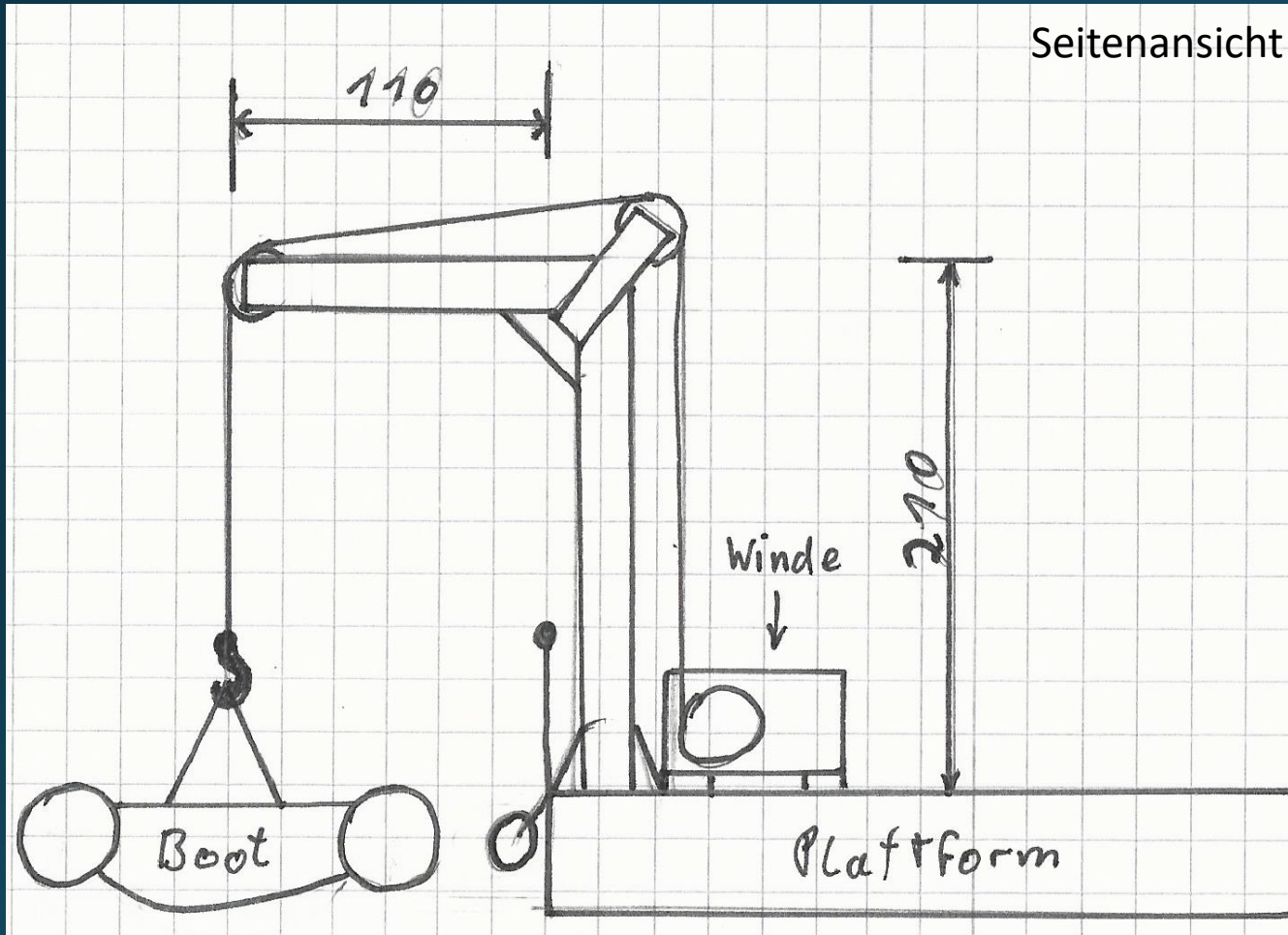

# Rollensystem

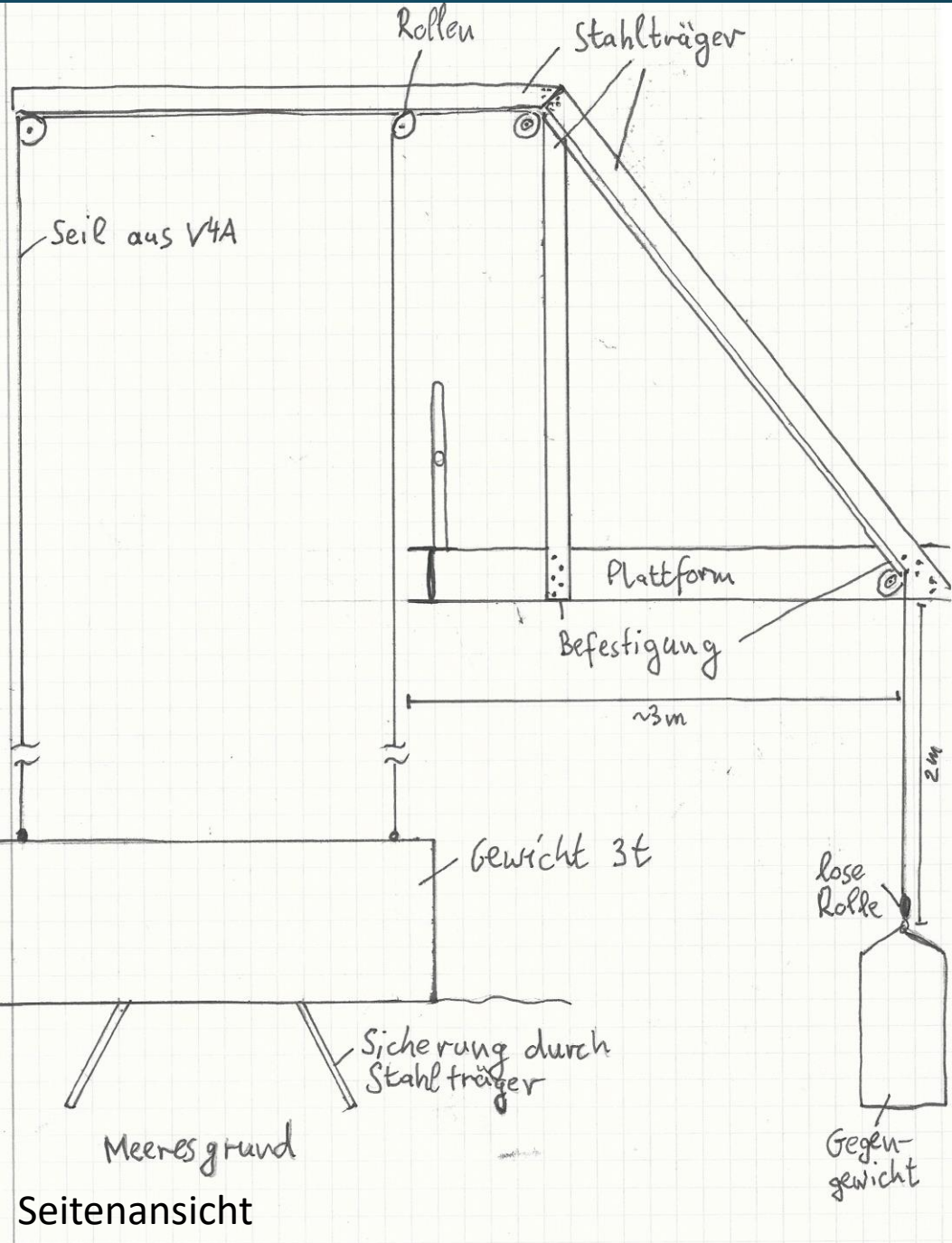

# Fendersystem

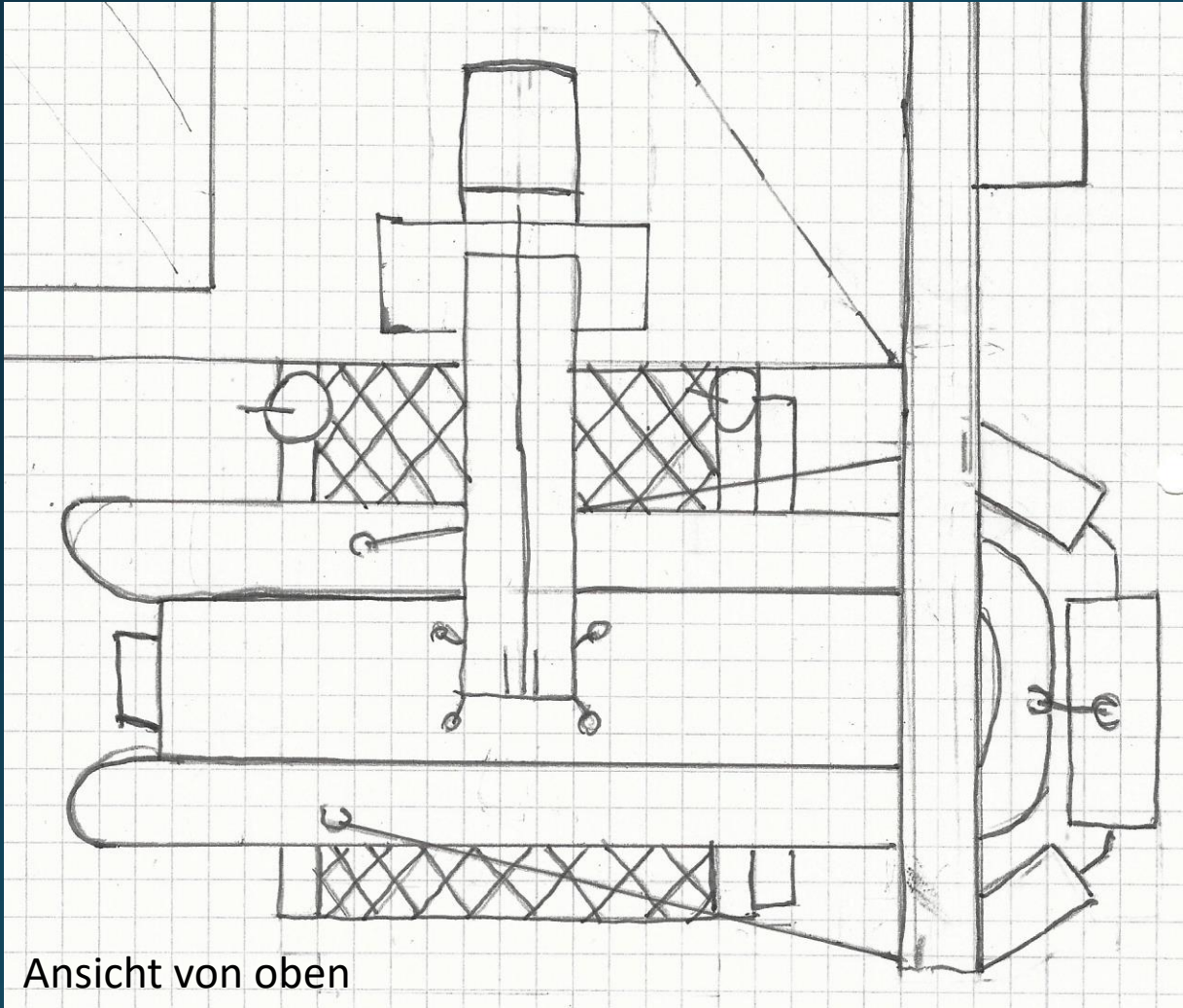

Ansicht von oben

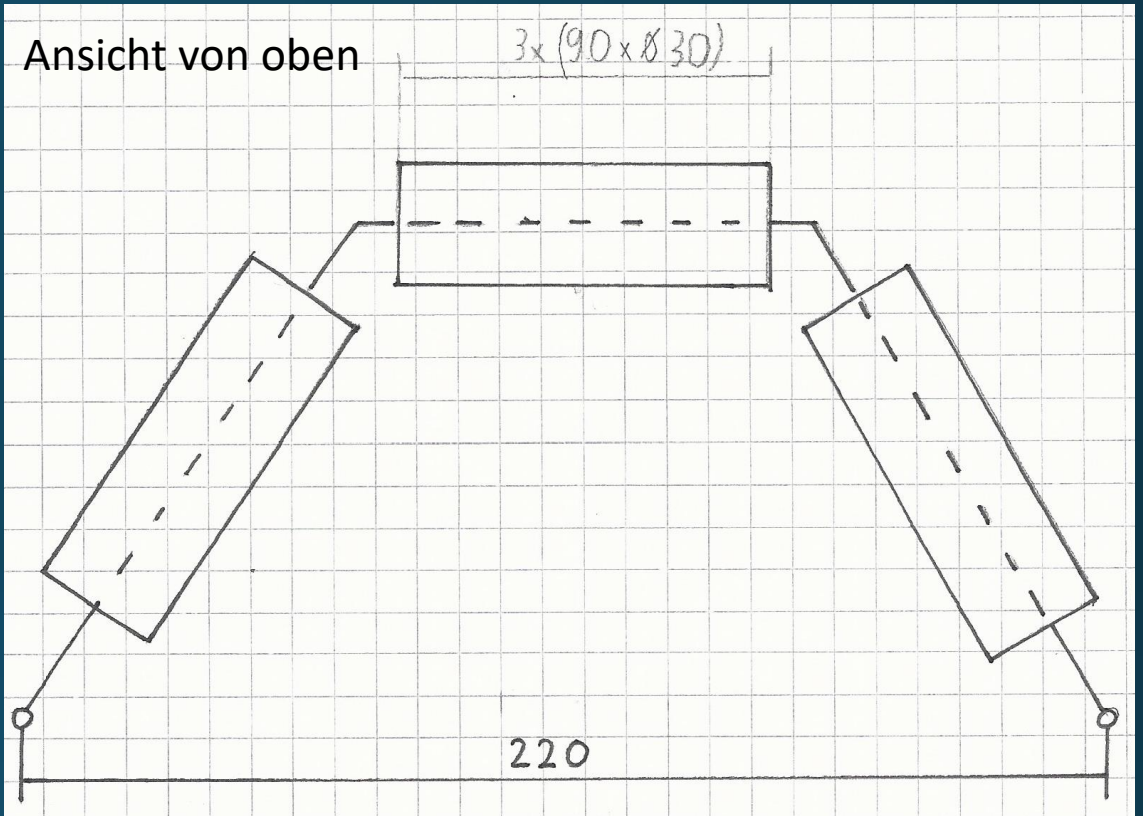

Ansicht von oben

3x (90x830)

220

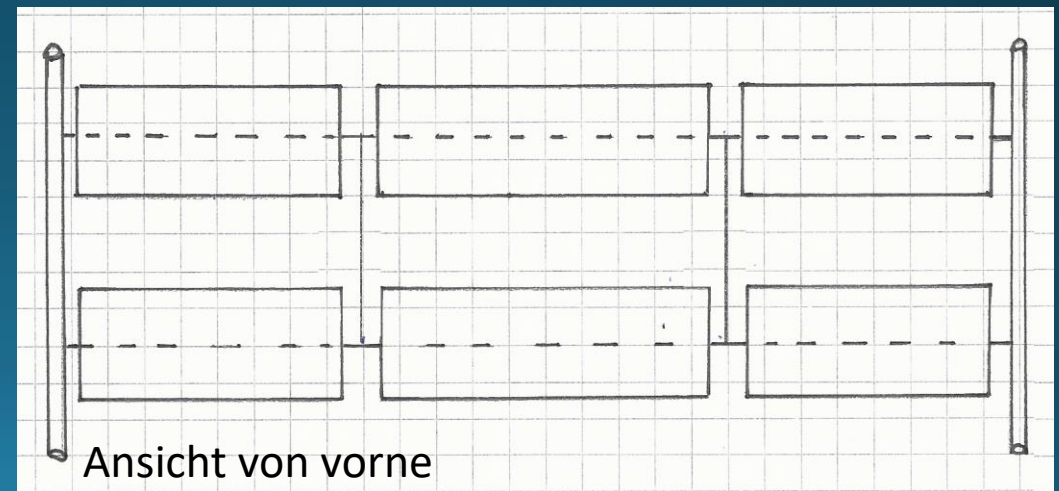

Ansicht von vorne

# Steuerung

Seitenansicht

## Aufbau Motor / Winde Schaltsystem

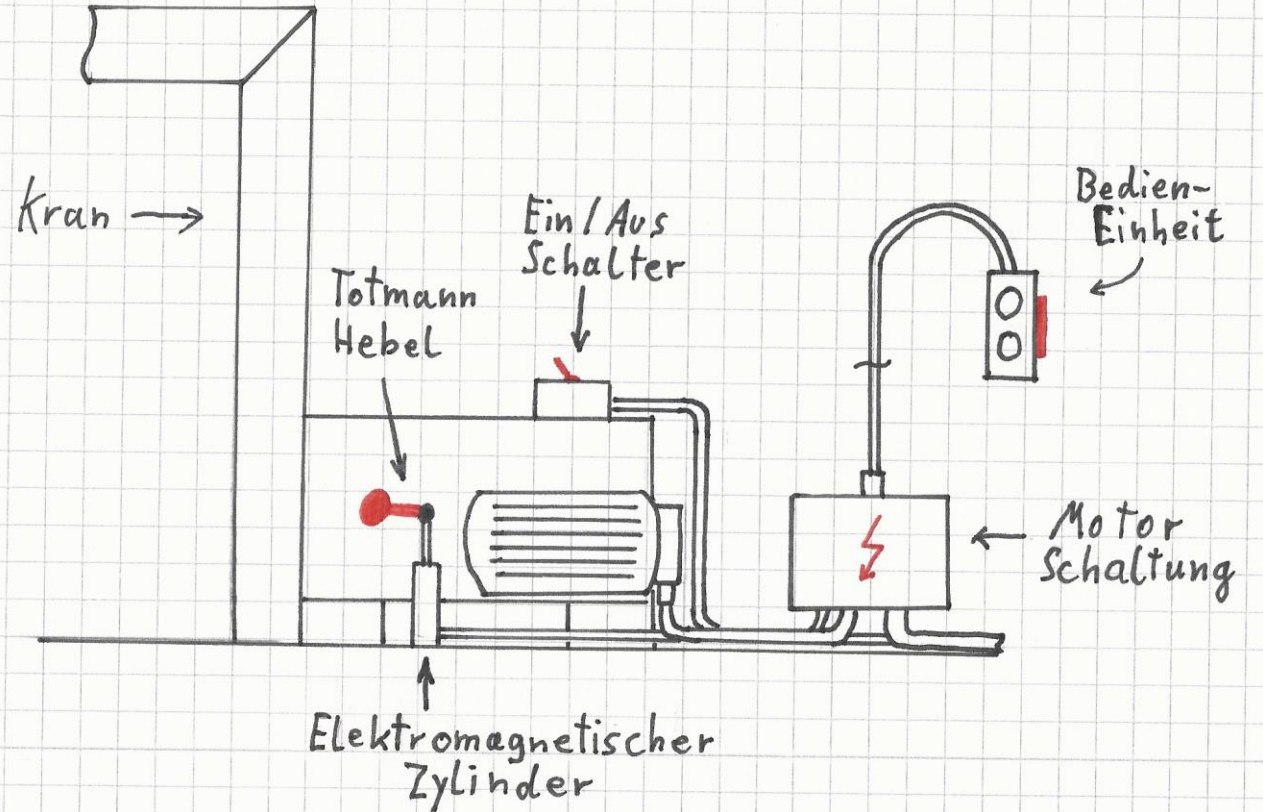
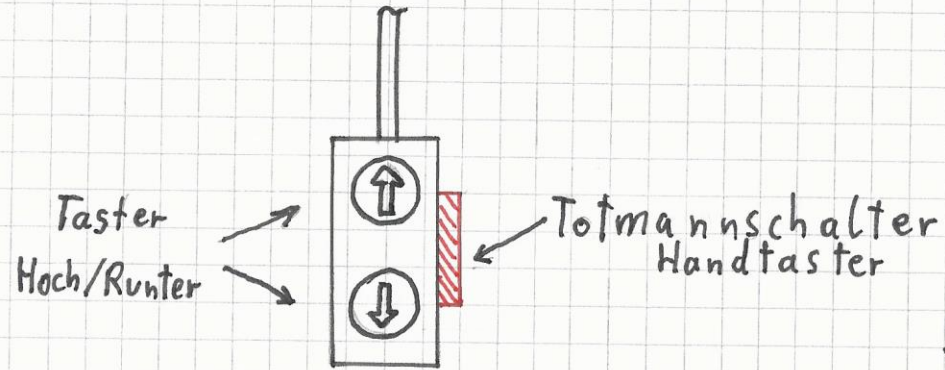



# Stromversorgung

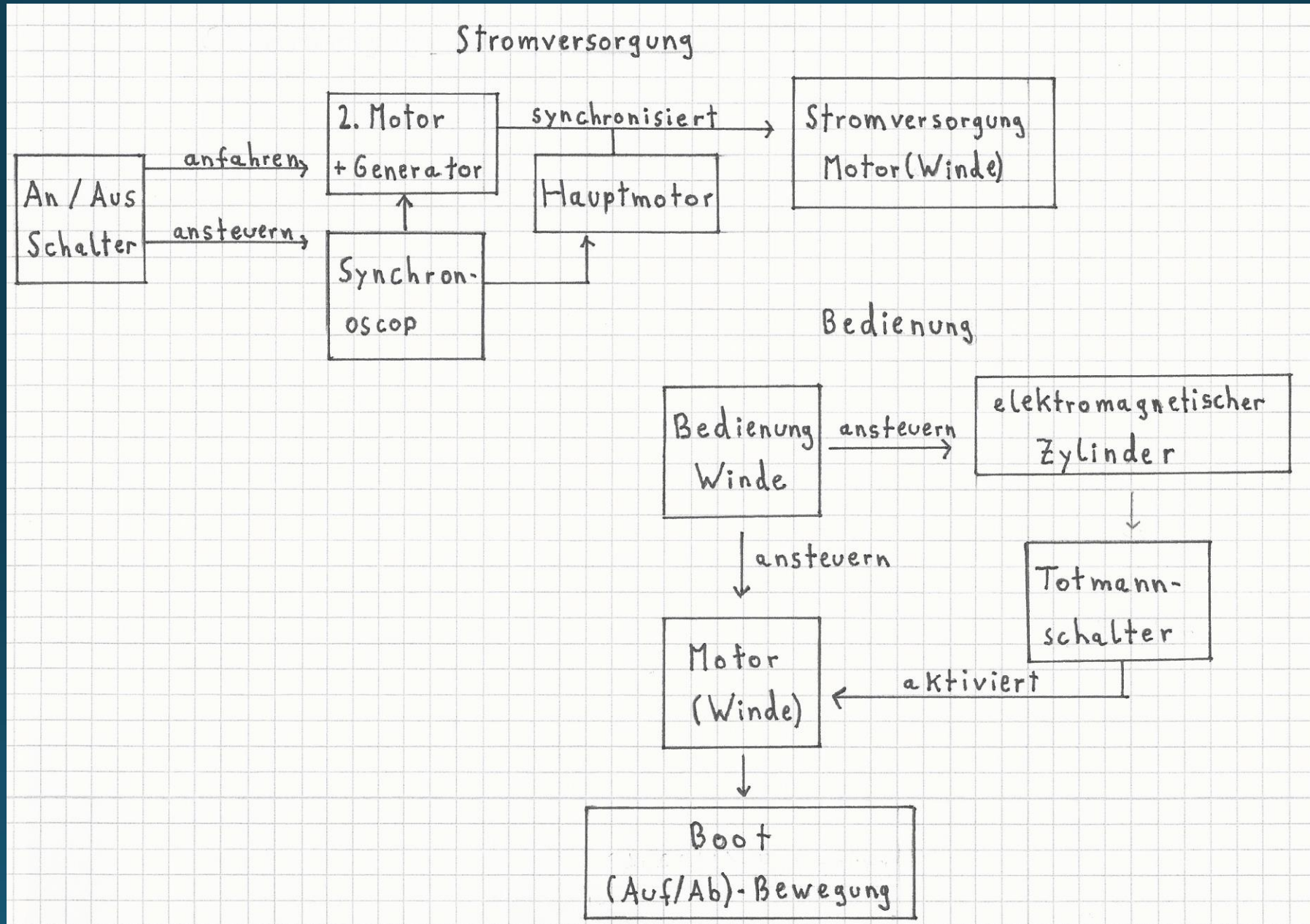

# Kosten und Gewicht

- Gesamtgewicht auf der Plattform: 2,3t
- Gesamtkosten: 66.500€
- Wartungskosten ca. 2.000€ pro Jahr